

SPLIT TYPE ROOM AIR CONDITIONER INSTALLATION MANUAL

(P/N 9314788017-01)

(MODEL: MW12Y1F/MR12Y1F, MW12C1F/MR12C1F
MW09Y1F/MR09Y1F, MW09C1F/MR09C1F)

ENGLISH

IMPORTANT!

Please Read Before Starting

This air conditioning system meets strict safety and operating standards. As the installer or service person, it is an important part of your job to install or service the system so it operates safely and efficiently.

For safe installation and trouble-free operation, you must:

- Carefully read this instruction booklet before beginning.
- Follow each installation or repair step exactly as shown.
- Observe all local, state, and national electrical codes.
- Pay close attention to all danger, warning, and caution notices given in this manual.

WARNING: This symbol refers to a hazard or unsafe practice which can result in severe personal injury or death.

CAUTION: This symbol refers to a hazard or unsafe practice which can result in personal injury and the potential for product or property damage.

- Hazel alerting symbols



Electrical



Safety / alert

If Necessary, Get Help

These instructions are all you need for most installation sites and maintenance conditions. If you require help for a special problem, contact our sales/service outlet or your certified dealer for additional instructions.

In Case of Improper Installation

The manufacturer shall in no way be responsible for improper installation or maintenance service, including failure to follow the instructions in this document.

SPECIAL PRECAUTIONS

When Wiring

ELECTRICAL SHOCK CAN CAUSE SEVERE PERSONAL INJURY OR DEATH. ONLY A QUALIFIED, EXPERIENCED ELECTRICIAN SHOULD ATTEMPT TO WIRE THIS SYSTEM.

- Do not supply power to the unit until all wiring and tubing are completed or reconnected and checked.
- Highly dangerous electrical voltages are used in this system. Carefully refer to the wiring diagram and these instructions when wiring. Improper connections and inadequate grounding can cause **accidental injury or death.**
- **Ground the unit** following local electrical codes.

- Connect all wiring tightly. Loose wiring may cause overheating at connection points and a possible fire hazard.

When Transporting

Be careful when picking up and moving the indoor and outdoor units. Get a partner to help, and bend your knees when lifting to reduce strain on your back. Sharp edges or thin aluminum fins on the air conditioner can cut your fingers.

When Installing...

...In a Ceiling or Wall

Make sure the ceiling/wall is strong enough to hold the unit's weight. It may be necessary to construct a strong wood or metal frame to provide added support.

...In a Room

Properly insulate any tubing run inside a room to prevent "sweating" that can cause dripping and water damage to walls and floors.

...In Moist or Uneven Locations

Use a raised concrete pad or concrete blocks to provide a solid, level foundation for the outdoor unit. This prevents water damage and abnormal vibration.

...In an Area with High Winds

Securely anchor the outdoor unit down with bolts and a metal frame. Provide a suitable air baffle.

...In a Snowy Area (for Heat Pump-type Systems)

Install the outdoor unit on a raised platform that is higher than drifting snow. Provide snow vents.

When Connecting Refrigerant Tubing

- Keep all tubing runs as short as possible.
- Use the flare method for connecting tubing.
- Apply refrigerant lubricant to the matching surfaces of the flare and union tubes before connecting them, then tighten the nut with a torque wrench for a leak-free connection.
- Check carefully for leaks before starting the test run.

NOTE:

Depending on the system type, liquid and gas lines may be either narrow or wide. Therefore, to avoid confusion the refrigerant tubing for your particular model is specified as either "small" or "large" rather than as "liquid" or "gas".

When Servicing

- Turn the power OFF at the main circuit breaker panel before opening the unit to check or repair electrical parts and wiring.
- Keep your fingers and clothing away from any moving parts.
- Clean up the site after you finish, remembering to check that no metal scraps or bits of wiring have been left inside the unit being serviced.
- After installation, explain correct operation to the customer, using the operating manual.

This air conditioner uses new refrigerant HFC (R410A).

The basic installation work procedures are the same as conventional refrigerant (R22) models. However, pay careful attention to the following points:

- (1) Since the working pressure is 1.6 times higher than that of conventional refrigerant(R22) models, some of the piping and installation and service tools are special.(See the table below.)
Especially, when replacing a conventional refrigerant(R22) model with a new refrigerant R410A model, always replace the conventional piping and flare nuts with the R410A piping and flare nuts.
- (2) Models that use refrigerant R410A have a different charging port thread diameter to prevent erroneous charging with conventional refrigerant(R22) and for safety. Therefore, check beforehand.[The charging port thread diameter for R410A is 1/2 threads per inch.]
- (3) Be more careful that foreign matter (oil, water, etc.) does not enter the piping than with refrigerant(R22) models. Also, when storing the piping ,securely seal the opening by pinching, taping, etc.
- (4) When charging the refrigerant, take into account the slight change in the composition of the gas and liquid phases, and always charge from the liquid phase side whose composition is stable.

Special tools for R410A

Tool name	Contents of change
Gauge manifold	Pressure is high and cannot be measured with a conventional gauge. To prevent erroneous mixing of other refrigerants, the diameter of each port has been changed. It is recommended the gauge with seals-0.1 to 5.3 MPa (-1 to 53 bar) for high pressure. -0.1 to 3.8 MPa (-1 to 38 bar) for low pressure.
Charge hose	To increase pressure resistance, the hose material and base size were changed.
Vacuum pump	A conventional vacuum pump can be used by installing a vacuum pump adapter.
Gas leakage detector	Special gas leakage detector for HFC refrigerant R410A.

Copper pipes

It is necessary to use seamless copper pipes and it is desirable that the amount of residual oil is less than 40 mg/10m. Do not use copper pipes having a collapsed, deformed or discolored portion (especially on the interior surface). Otherwise, the expansion value or capillary tube may become blocked with contaminants.

As an air conditioner using R410A incurs pressure higher than when using R22, it is necessary to choose adequate materials. Thicknesses of copper pipes used with R410A are as shown in Table1.Never use copper pipes thinner than 0.8mm even when it is available on the market.

Table 1 Thicknesses of Annealed Copper Pipes

		Thickness (mm)	
Nominal diameter	Outer diameter (mm)	R410A	[ref.] R22
1/4	6.35	0.80	0.80
3/8	9.52	0.80	0.80

⚠ WARNING

- (1) **Do not use the existing (for R22) piping and flare nuts.**
 - If the existing materials are used, the pressure inside the refrigerant cycle will rise and cause breakage, injury, etc.(Use the special R410A materials.)
- (2) **When installing and relocating the air conditioner, do not mix gases other than the specified refrigerant(R410A) to enter the refrigerant cycle.**
 - If air or other gas enters the refrigerant cycle, the pressure inside the cycle will rise to an abnormally high value and cause breakage, injury, etc.

⚠ CAUTION

When installing pipes shorter than 3m, sound of the outdoor unit will be transferred to the indoor unit, which will cause large operating sound or some abnormal sound.

INDOOR UNIT

1. CUTTING THE HOLE IN THE WALL FOR THE CONNECTING PIPING

- Cut a 3-2/16" (80 mm) diameter hole in the wall at the position shown in (Fig.1).
- When cutting the wall hole at the inside of the installation frame, cut the hole within the range of the left and right center marks 3/8" (10 mm) below the installation frame. When cutting the wall hole at the outside of the installation frame, cut the hole at least 3/8" (10 mm) below less.
- Cut the hole so that the outside end is lower 3/16" to 3/8" (5 to 10 mm) than the inside end.
- Always align the center of the wall hole. If misaligned, water leakage will occur.
- Cut the wall pipe to match the wall thickness, stick it into the wall cap, fasten the cap with vinyl tape, and stick the pipe through the hole. (The connection pipe is supplied in the installation set.) (Fig.1)
- For left piping and right piping, cut the hole a little lower so that drain water will flow freely. (Fig.1)

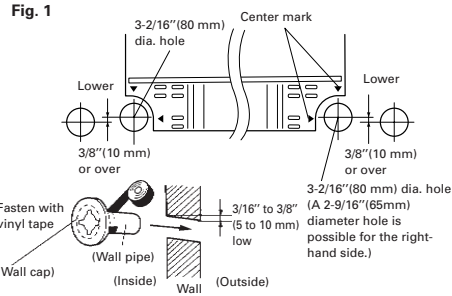

2. INSTALLING THE WALL HOOK BRACKET

- Install the wall hook bracket so that it is correctly positioned horizontally and vertically. If the wall hook bracket is tilted, water will drip to the floor.
- Install the wall hook bracket so that it is strong enough to withstand the weight of an adult.
 - Fasten the wall hook bracket to the wall with 6 or more screws through the holes near the outer edge of the bracket.
 - Check that there is no rattle at the wall hook bracket.

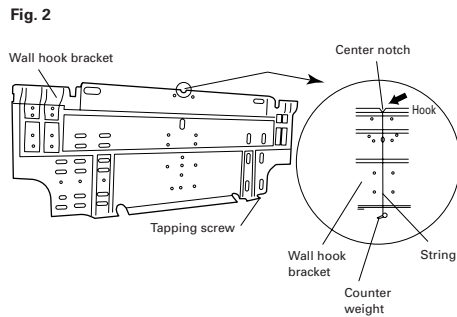

WARNING

If the wall pipe is not used, the cord interconnecting the indoor and outdoor units may touch metal and cause electric leakage.

CAUTION

Install the wall hook bracket horizontally and perpendicularly.

3. FORMING THE DRAIN HOSE AND PIPE

[Rear piping, Right piping, Bottom piping]

- Install the indoor unit piping in the direction of the wall hole and bind the drain hose and pipe together with vinyl tape. (Fig. 3)
- Install the piping so that the drain hose is at the bottom.
- Wrap the pipes of the indoor unit that are visible from the outside with decorative tape.

[For Left rear piping, Left piping]

Interchange the drain cap and the drain hose.

CAUTION

- In order to align the drain hose and drain cap, be sure to insert securely and vertically. Incline insertion will cause water leakage.
- When inserting, be sure not to attach any material besides water. If any other material is attached, it will cause deterioration and water leakage.
- After removing drain hose, be sure not to forget mounting drain cap.
- Be sure to fix the drain hose with tape to the bottom of piping.

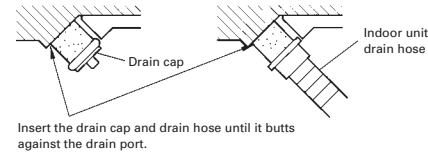
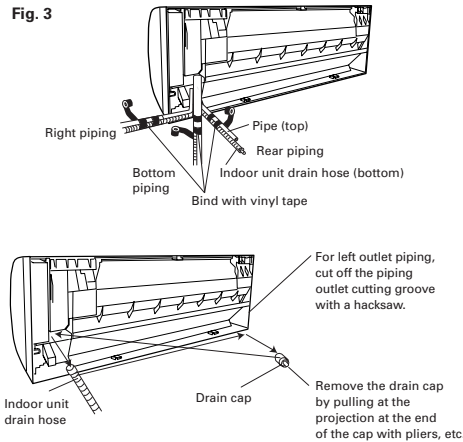

- For left piping and left rear piping, align the marks on the wall hook bracket and shape the connection pipe.
- Bend the connection piping at a bend radius of 2-3/4" (70 mm) or more and install no more than 1-3/8" (35 mm) from the wall.
- After passing the indoor piping and drain hose through the wall hole, hang the indoor unit on the hooks at the top and bottom of the wall hook bracket.

[Installing the indoor unit]

- Hang the indoor unit from the hooks at the top of the wall hook bracket.
- Insert the spacer, etc. between the indoor unit and the wall hook bracket and separate the bottom of the indoor unit from the wall.

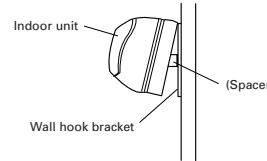
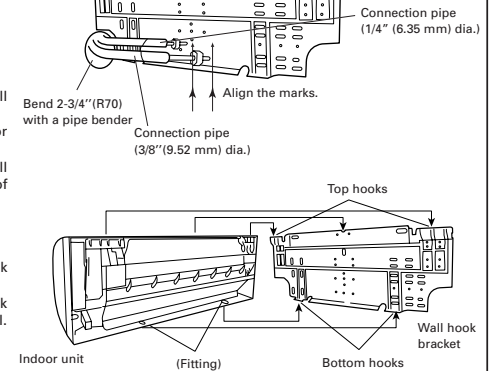

Fig. 4



After hooking the indoor unit to the top hook, hook the fittings of the indoor unit to the two bottom hooks while lowering the unit and pushing it against the wall.

4. CONNECTING THE PIPING

CONNECTION

- Install the outdoor unit wall cap (supplied with the optional installation set or procured at the site) to the wall pipe.
- Connect the outdoor unit and indoor unit piping.
- After matching the center of the flare surface and tightening the nut hand tight, tighten the nut to the specified tightening torque with a torque wrench. (Tighten the flare nut of the outdoor unit 3-way valve after air purging.)

FLARING

- Cut the connection pipe to the necessary length with a pipe cutter.
- Hold the pipe downward so that cuttings will not enter the pipe and remove the burrs.
- Insert the flare nut onto the pipe and flare the pipe with a flaring tool.

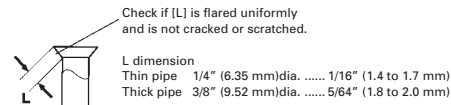

BENDING PIPES

The pipes are shaped by your hands. Be careful not to collapse them.

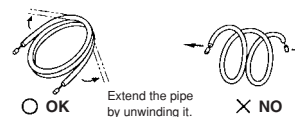

Do not bend the pipes in an angle more than 90°. When pipes are repeatedly bent or stretched, the material will harden, making it difficult to bend or stretch them any more. Do not bend or stretch the pipes more than three times.

Fig. 5

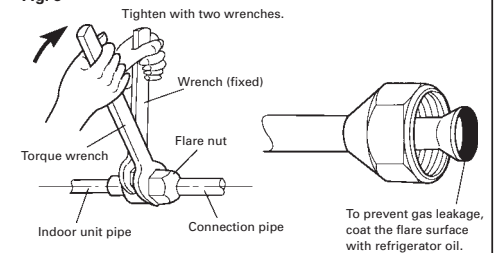

Table 2 Flare nut tightening torque

Flare nut	Tightening torque	Tightening torque standard (using a 20 cm wrench)
1/4" (6.35 mm)dia.	11.57 to 13.02 ft·lbs (160 to 180 kgf·cm)	Wrist strength
3/8" (9.52 mm)dia.	21.70 to 30.38 ft·lbs (300 to 420 kgf·cm)	Arm strength

CAUTION

- Fasten a flare nut with a torque wrench as instructed in this manual. If fastened too tight, the flare nut may be broken after a long period of time and cause a leakage of refrigerant.
- During installation, make sure that the refrigerant pipe is attached firmly before you run the compressor. Do not operate the compressor under the condition of refrigerant piping not attached properly with 2-way or 3-way valve open. This may cause abnormal pressure in the refrigeration cycle that leads to breakage and even injury.

GENERAL

This INSTALLATION MANUAL briefly outlines where and how to install the air conditioning system. Please read over the entire set of instructions for the indoor and outdoor units and make sure all accessory parts listed are with the system before beginning.

1. TYPE OF COPPER PIPE AND INSULATION MATERIAL

Copper tubing for connectin the outdoor unit to the indoor unit and insulation material is available for purchase locally. When you purchase them, please specify the following.

A. Deoxidized annealed copper pipe for refrigerant piping as:

Table 3

Small pipe		Large pipe	
Outer diameter	Thickness	Outer diameter	Thickness
1/4" (6.35 mm)	1/32" (0.8 mm)	3/8" (9.52 mm)	1/32" (0.8 mm)

Cut each pipe to the appropriate length +12" (30 cm) to 16" (40 cm) to dampen vibration between units.

B. Foamed polyethylene insulation for copper pipes as required to precise length of piping. Wall thickness of the insulation should not be less than 5/16" (8 mm).

C. Use insulated copper wire for field wiring.

CAUTION

Check local electrical codes and regulations before obtaining wire. Also, check any specified instructions or limitations.

2. ADDITIONAL MATERIALS REQUIRED FOR INSTALLATION

- Refrigeration (armored) tape
- Insulated staples or clamps for connecting wire (See your local electrical codes.)
- Putty
- Refrigeration lubricant
- Clamps or saddles to secure refrigerant piping

3. OPERATING RANGE

Table 4

	Cooling/Dry Mode	Heating Mode
Outdoor temperature	About 32 to 115 °F	About 17 to 75 °F
Indoor temperature	About 64 to 90 °F	88 °F or less
Indoor Humidity	Outdoor temperature 68°F or above	—
	Outdoor temperature below 68°F	About 50% or less

ADDITIONAL CHARGE

Refrigerant suitable for a piping length of 25 ft (7.5 m) is charged in the outdoor unit at the factory. When the piping is longer than 25 ft (7.5 m), additional charging is necessary. For the additional amount, see the table below.

Table 5

Pipe length	25 ft (7.5 m)	33 ft (10 m)	49 ft (15 m)
Additional refrigerant	None	1.8 oz (50 g)	5.3 oz (150 g)

Between 25 ft (7.5 m) and 49 ft (15 m), when using a connection pipe other than that in the table, charge additional refrigerant with 0.7 OZ/3.3 ft (20g/1 m) as the criteria.







CAUTION

- When adding refrigerant, add the refrigerant from the charging port at the completion of work.
- The maximum length of the piping is 15 m. If the units are further apart than this, correct operation can not be guaranteed.

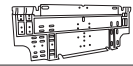
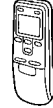
STANDARD ACCESSORIES

The following installation accessories are supplied. Use them as required.

INDOOR UNIT ACCESSORIES

Name and Shape	Q'ty	Use
Wall hook bracket 	1	For indoor unit installation
Remote control unit 	1	Use for air conditioner operation
Battery (penlight) 	2	For remote control unit
Cloth tape 	1	For indoor unit installation
Remote control unit holder 	1	Use as remote control unit holder
Tapping screw (big) (ø4 × 20) 	8	For wall hook bracket installation
Tapping screw (small) (ø3 × 12) 	2	For remote control unit holder installation

The following items are necessary to install this air conditioner. (The items are not included with the air conditioner and must be purchased separately.)

Name	Q'ty
Connection pipe assembly	1
Connection cord (3-conductor)	1
Wall pipe	1
Decorative tape	1
Vinyl tape	1
Wall cap	1
Saddle	1 set
Drain hose	1
Tapping screws	1 set
Sealant	1

ELECTRICAL REQUIREMENT

Always make the air conditioner power supply a special branch circuit and provide a special switch and receptacle. Do not extend the power cord.

CAUTION

	9000 BTU/h	12000 BTU/h
MINIMUM CIRCUIT AMPACITY	12 A	15 A
MAXIMUM OVERCURRENT PROTECTION (TIME DELAY FUSE OR HACR TYPE CIRCUIT BREAKER)	15 A	20 A

SELECTING THE MOUNTING POSITION

Decide the mounting position with the customer as follows:

1. INDOOR UNIT

- Install the indoor unit level on a strong wall which is not subject to vibration.
- The inlet and outlet ports should not be obstructed: the air should be able to blow all over the room.
- Install the unit near an electric outlet or special branch circuit.
- Do not install the unit where it will be exposed to direct sunlight.
- Install the unit where connection to the outdoor unit is easy.
- Install the unit where the drain pipe can be easily installed.
- Take servicing, etc. into consideration and leave the spaces shown in (Fig. 2). Also install the unit where the filter can be removed.

2. OUTDOOR UNIT

- If possible, do not install the unit where it will be exposed to direct sunlight. (If necessary, install a blind that does not interfere with the air flow.)
- Do not install the unit where a strong wind blows or where it is very dusty.
- Do not install the unit where people pass.
- Take you neighbors into consideration so that they are not disturbed by air blowing into their windows or by noise.
- Provide the space shown in Fig. 2 so that the air flow is not blocked. Also for efficient operation, leave open three of the four directions front, rear, and both sides.

WARNING

Install at a place that can withstand the weight of the indoor and outdoor units and install positively so that the units will not topple or fall.

CAUTION

- Do not install where there is the danger of combustible gas leakage.
- Do not install near heat sources.
- If children under 10 years old may approach the unit, take preventive measures so that they can not reach the unit.

[Indoor unit piping direction]

The piping can be connected in the 6 directions indicated in (Fig. 6). When the piping is connected in direction ②, ③, ④ or ⑤, cut along the piping groove in the side of the front cover with a hacksaw.

Fig. 6

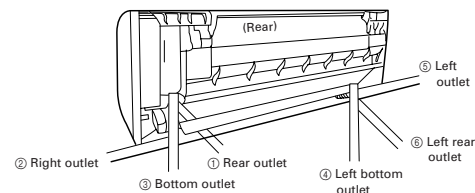

INSTALLATION DIAGRAM OF INDOOR AND OUTDOOR UNITS

Fig. 7

[INDOOR UNIT]

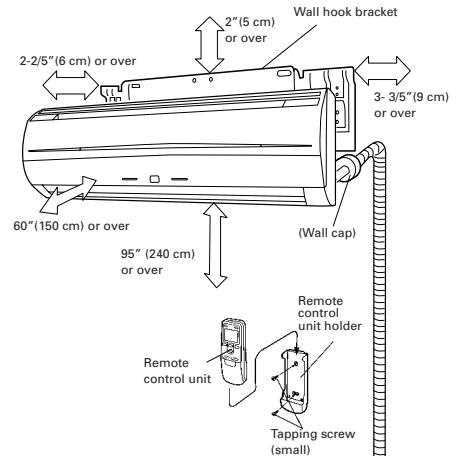

Connection Cord
14AWG

[OUTDOOR UNIT]

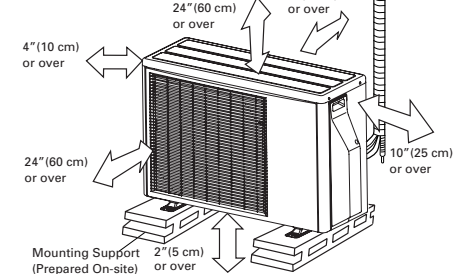

[Reverse cycle only]

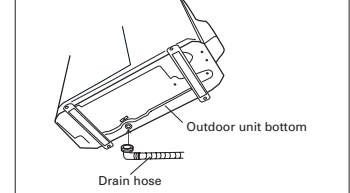
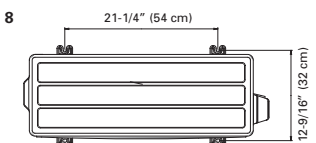

Fig. 8



OUTDOOR UNIT

OUTDOOR UNIT INSTALLATION

- Set the unit on a strong stand, such as one made of concrete blocks to minimize shock and vibration.
- Do not set the unit directly on the ground because it will cause trouble.

Connector cover removal

- Remove the two mounting screws.

Installing the connector cover

- (1) After inserting the three front hooks, then insert the rear hook.
- (2) Tighten the two mounting screws.

⚠ WARNING

- (1) **Install the unit where it will not be tilted by more than 5°.**
- (2) **When installing the outdoor unit where it may be exposed to strong wind, fasten it securely.**

Fig. 9

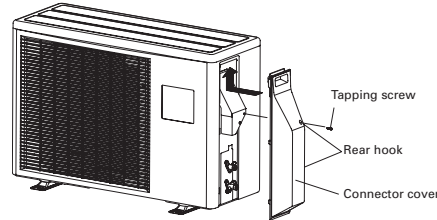

Always use the screws as shown above.
Do not select the top and bottom screws incorrectly.

AIR PURGE

Always use a vacuum pump to purge the air.
Refrigerant for purging the air is not charged in the outdoor unit at the factory.

Close the high pressure side valve of the gauge manifold fully and do not operate it during the following work.

1. Check if the piping connections are secure.
2. Check that the stems of 2-way valve and 3-way valve are closed fully.
3. Connect the gauge manifold charge hose to the charging port of the 3-way valve (side with the projection for pushing in the valve core).
4. Open the low pressure side valve of the gauge manifold fully.
5. Operate the vacuum pump and start pump down.
6. Slowly loosen the flare nut of the 3-way valve and check if air enters, then retighten the flare nut. (When the flare nut is loosened the operating sound of the vacuum pump changes and the reading of the compound pressure gauge goes from minus to zero.)
7. Pump down the system for at least 15 minutes, then check if the compound pressure gauge reads -0.1 MPa (-76 cmHg, -1 bar).
8. At the end of pump down, close the low pressure side gauge of the gauge manifold fully and stop the vacuum pump.
9. Slowly loosen the valve stem of the 3-way valve. When the compound pressure gauge reading reaches 0.1-0.2 MPa, retighten the valve stem and disconnect the charge hose from the 3-way valve charging port. (If the stem of the 3-way valve is opened fully before the charge hose is disconnected, it may be difficult to disconnect the charge hose.)

⚠ CAUTION

- (1) **Refrigerant must not be discharged into atmosphere.**
- (2) **After connecting the piping, check the joints for gas leakage with gas leak detector.**

10. Fully open the valve stems of the 2-way valve and 3-way valve using a hexagon wrench. (After the valve stem begins to turn, turn it with a torque of less than 2.17ft·lbs (30 kgf·cm) until it stops turning.)
11. Firmly tighten the 2-way valve and 3-way valve blank cap and the charging port cap.

Fig. 10

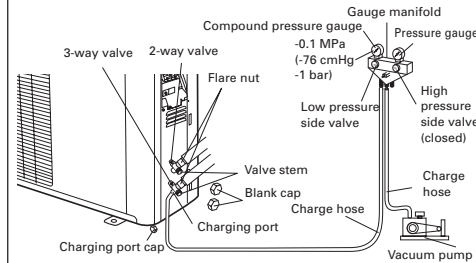

Table 6

	Tightening torque
Blank cap (2-way valve)	14.47 to 18.08 ft·lbs (200 to 250 kgf·cm)
Blank cap (3-way valve)	20.25 to 23.15 ft·lbs (280 to 320 kgf·cm)
Charging port cap	9.04 to 11.57 ft·lbs (125 to 160 kgf·cm)

ELECTRICAL WIRING (OUTDOOR UNIT)

1. Remove the screws, then remove the control box cover.
2. Fasten the Inter unit wire harness and power supply to the conduit holder using the lock nut.
3. Connect inter-unit wire harness and power supply to the terminal.
Refer to the wiring diagram
4. Use the screws to install the control box cover.

⚠ WARNING

Be sure to comply with local codes while running the wire from the indoor unit to the outdoor unit (size of wire and wiring method, etc.).

Every wire must be connected firmly.

No wire should be allowed to touch refrigerant tubing, the compressor or any moving part.

Loose wiring may cause the terminal to overheat or result in unit malfunction. A fire hazard may also exist. Therefore, be sure all wiring is tightly connected.

Connect wires to the matching numbers of terminals.

NOTE:

- Connector trade size for this unit is 1/2" (12.7 mm). The connector can be bought at a hardware store. Refer to "How to connect wiring to the terminals" for instructions on connecting depending on the wire type you are using.
- The fuse located in the outdoor unit provides power supply protection and may blow when power is applied if the system has been incorrectly wired. (Cooling model)

Fig. 11

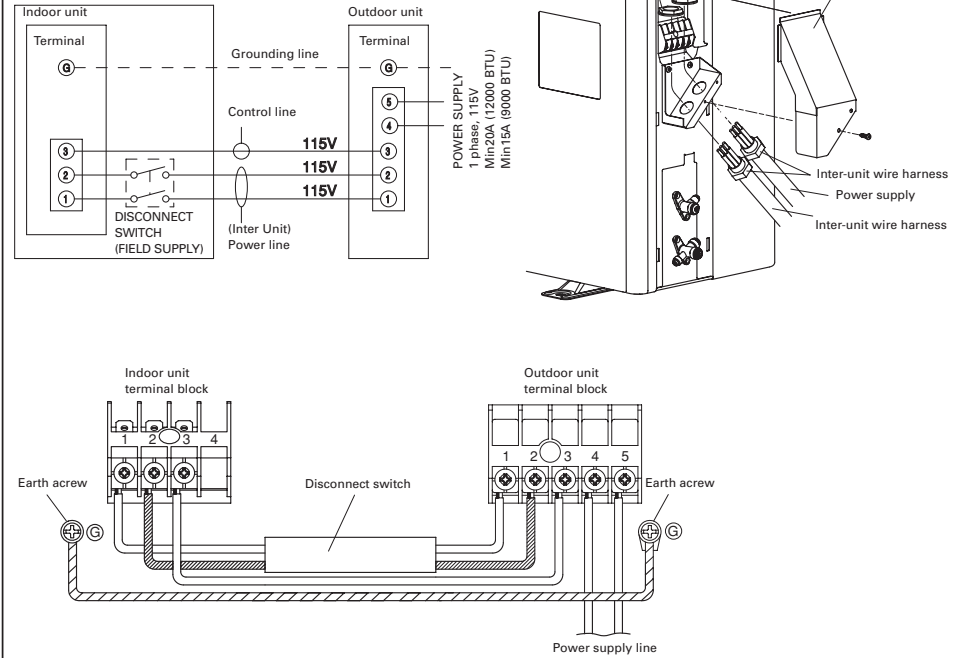

ELECTRICAL WIRING (INDOOR UNIT)

HOW TO THE INSTALL THE INTER-UNIT WIRE HARNESS

1. Remove the screws, then remove the conduit holder.
2. Fasten the inter-unit wire harness to the conduit holder using the lock nut.
IMPORTANT: Refer to fig. 20 about the length of inter-unit wire harness.
3. Use the screws to install the conduit holder with which Inter-unit wire harness is included.
4. Remove the screws, then remove the wire clammer.
5. Connect inter-unit wire harness to the terminal.
Refer to the wiring diagram.
6. Use the screws to install the wire clammer.

ELECTRICAL WIRING (INDOOR UNIT)

1. Remove the screws, then remove the cord clamp.
2. Connect connection cord to the terminal.
Refer to the wiring diagram
3. Use the screws to install the cord clamp.

Fig. 13

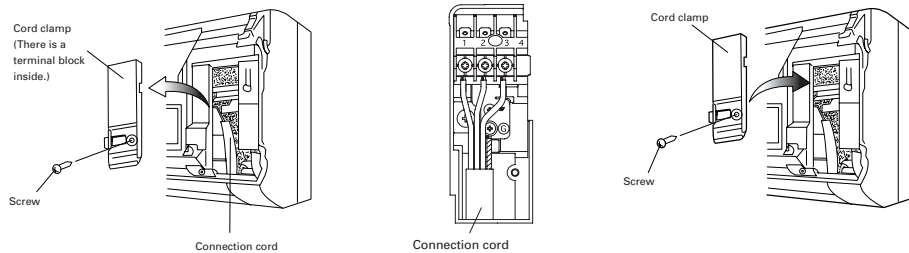
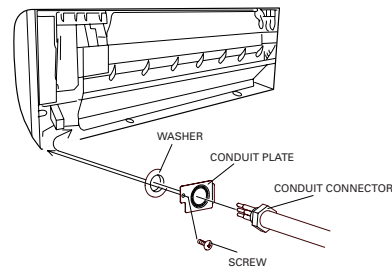

Fig. 12



HOW TO CONNECT WIRING TO THE TERMINALS

A. For solid core wiring (or F-cable)

- (1) Cut the wire end with a wire cutter or wire-cutting pliers, then strip the insulation to about 15/16" (25 mm) to expose the solid wire.
- (2) Using a screwdriver, remove the terminal screw(s) on the terminal board.
- (3) Using pliers, bend the solid wire to form a loop suitable for the terminal screw.
- (4) Shape the loop wire properly, place it on the terminal board and tighten securely with the terminal screw using a screwdriver.

B. For strand wiring

- (1) Cut the wire end with a wire cutter or wire-cutting pliers, then strip the insulation to about 3/8" (10 mm) to expose the strand wiring.
- (2) Using a screwdriver, remove the terminal screw(s) on the terminal board.
- (3) Using a round terminal fastener or pliers, securely clamp a round terminal to each stripped wire end.
- (4) Position the round terminal wire, and replace and tighten the terminal screw using a screwdriver.

Fig. 14

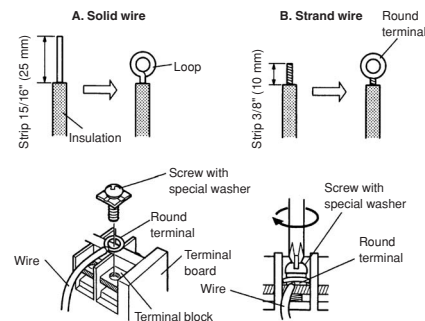

FINISHING

- (1) Insulate between pipes.
 - For rear, right, and bottom piping, overlap the connection pipe heat insulation and indoor unit pipe heat insulation and bind them with vinyl tape so that there is no gap.
 - For left and left rear piping, butt the connection pipe heat insulation and indoor unit pipe heat insulation together and bind them with and vinyl tape so that there is no gap.
 - For left and left rear piping, wrap the area which accommodates the rear piping housing section with cloth tape.
 - For left and left rear piping, bind the connection cord to the top of the pipe with vinyl tape.
 - For left and left rear piping, bundle the piping and drain hose together by wrapping them with cloth tape over the range within which they fit into the rear piping housing section.
- (2) Temporarily fasten the connection cord along the connection pipe with vinyl tape. (Wrap to about 1/3 the width of the tape from the bottom of the pipe so that water does not enter.)
- (3) Fasten the connection pipe to the outside wall with a saddle, etc.
- (4) Fill the gap between the outside wall pipe hole and the pipe with sealer so that rain water and wind cannot blow in.
- (5) Fasten the drain hose to the outside wall, etc.

Fig. 15

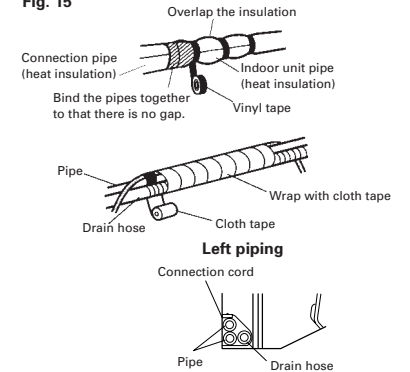
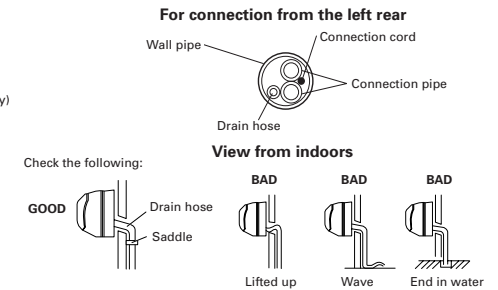
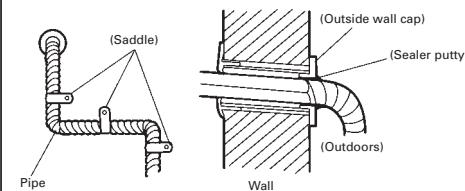

Fig. 16



FRONT PANEL REMOVAL AND INSTALLATION

THE INTAKE GRILLE REMOVAL

- (1) Open the intake grille.
- (2) Pull down the knob.
- (3) Lift the intake grille upward, until the axle at the top of the intake grille is removed.

THE INTAKE GRILLE INSTALLATION

- (1) The fixing axle of the intake grille is installed on the Panel.
- (2) Lay down the intake grille.

THE FRONT PANEL REMOVAL

- (1) Remove intake grille (Reference the intake grille removal.)
- (2) Remove four screws.
- (3) The thumb is hung on the lower part as shown in the figure, and it pulls to the front, pushing [-] mark, and bottom hooks (two position) is removed from wall hook bracket.
- (4) The front panel bottom is pulled to the front, and bottom hooks is removed indoor unit.
- (5) The front panel is pulled to the front, raising the upper surface, and a front panel is removed.

THE FRONT PANEL INSTALLATION

- (1) Firstly, fit the lower part of the front panel, and insert top and bottom hooks. (Three top sides, six bottom sides)
- (2) Four screws is attached.
- (3) The intake grille is attached.

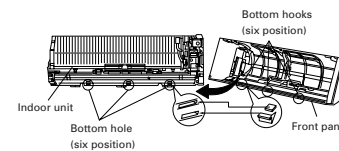
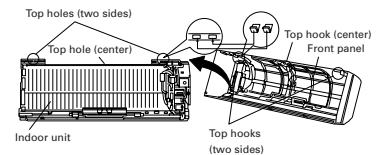
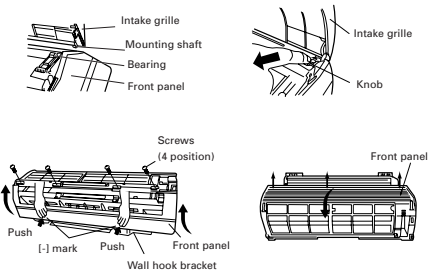

Fig. 4



CAUTION

- | | |
|---|--|
| (1) Match the terminal block numbers and connection cord colors with those of the outdoor unit. Erroneous wiring may cause burning of the electric parts. | (3) Always fasten the outside covering of the connection cord with the cord clamp. (If the insulator is chafed, electric leakage may occur.) |
| (2) Connect the connection cords firmly to the terminal block. Imperfect installation may cause a fire. | (4) Securely earth the power cord plug. |
| | (5) Do not use the earth screw for an external connector. Only use for interconnection between two units. |

TEST RUNNING

- Perform test operation and check items 1 and 2 below.
- For the test operation method, refer to the operating manual.
- The outdoor unit, may not operate, depending on the room temperature. In this case, press the test run button on the remote control unit while the air conditioner is running, (use a metallic object to short the two metal contacts under the battery compartment lid and send the "TEST RUN" signal from the remote control unit.)
- To end test operation, press the remote control unit START/STOP button. (When the air conditioner is run by pressing the test run button, the OPERATION indicator lamp and TIMER indicator lamp will simultaneously flash slowly.)

1. INDOOR UNIT

- (1) Is operation of each button on the remote control unit normal?
- (2) Does each lamp light normally?
- (3) Do the air flow-direction louver operate normally?
- (4) Is the drain normal?

2. OUTDOOR UNIT

- (1) Is there any abnormal noise and vibration during operation?
- (2) Will noise, wind, or drain water from the unit disturb the neighbors?
- (3) Is there any gas leakage?

Fig. 18

Short the two metal contacts under the battery compartment lid.

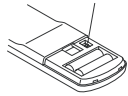

POWER

⚠ WARNING

- (1) The rated voltage of this product is 115 V AC 60 Hz.
- (2) Before turning on the power, check if the voltage is within the 115 V ± 10 %.
- (3) Always use a special branch circuit and install a special receptacle to supply power to the room air conditioner.
- (4) Use a circuit breaker and receptacle matched to the capacity of the air conditioner.
- (5) Do not extend the power cord.
- (6) Perform wiring work in accordance with standards so that the air conditioner can be operated safely and positively.
- (7) Install a leakage circuit breaker in accordance with the related laws and regulations and electric company standards.

⚠ CAUTION

- (1) The power source capacity must be the sum of the air conditioner current and the current of other electrical appliances. When the current contracted capacity is insufficient, change the contracted capacity.
- (2) When the voltage is low and the air conditioner is difficult to start, contact the power company the voltage raised.

CUSTOMER GUIDANCE

Explain the following to the customer in accordance with the operating manual:

- (1) Starting and stopping method, operation switching, temperature adjustment, timer, air flow switching, and other remote control unit operations.
- (2) Air filter removal and cleaning, and how to use the air louvers.
- (3) Give the operating and installation manuals to the customer.

REMOTE CONTROL UNIT INSTALLATION

⚠ CAUTION

- (1) Check that the indoor unit correctly receives the signal from the remote control unit, then install the remote control unit holder.
- (2) Select the remote control unit holder selection site by paying careful attention to the following: Avoid places in direct sunlight. Select a place that will not be affected by the heat from a stove, etc.

1. REMOTE CONTROL UNIT HOLDER INSTALLATION

- Install the remote control unit with a distance of 23 ft (7 m) between the remote control unit and the photocell as the criteria. However, when installing the remote control unit, check that it operates positively.
- Install the remote control unit holder to a wall, pillar, etc. with the tapping screw (Fig.19).

Fig. 19

Remote control unit holder fixing

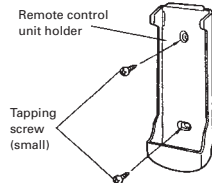

Remote control unit mounting

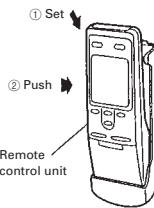

The method of adjusting inter-unit wire harness

To connect inter-unit wire harness to the terminal correctly, please refer to fig. 20 to adjust the length of the part of Inter-unit Wire harness ahead from conduit holder.

Fig. 20

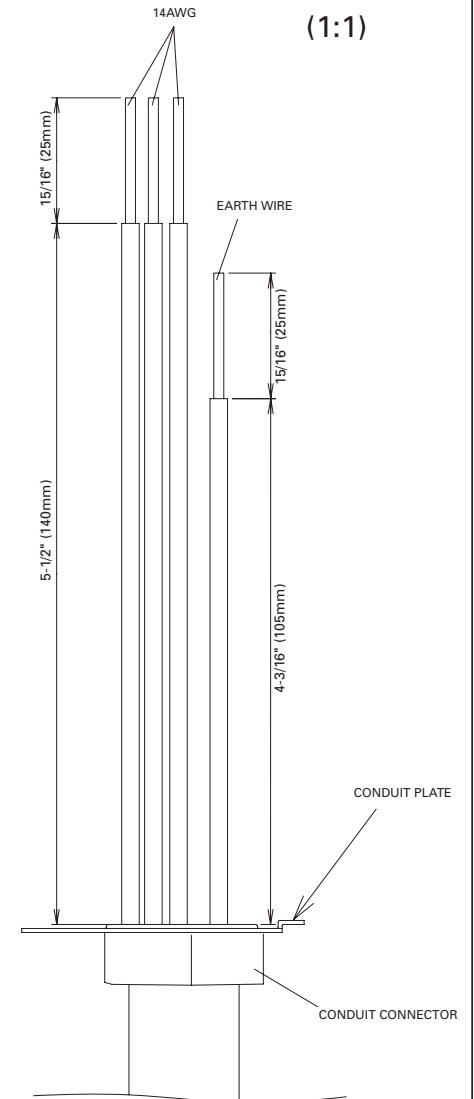

PUMP DOWN OPERATION

To avoid discharging refrigerant into the atmosphere at the time of relocation or disposal, recover refrigerant by doing the cooling operation according to the following procedure.

- (1) Do the air purging of the charge hose by connecting the charging hose of gauge manifold to the charging port of 3 way valve and opening the low-pressure valve slightly.
- (2) Close the valve stem of 2 way valve completely.
- (3) Start the cooling operation.

When using the remote control unit

Press the TEST RUN button after starting the cooling operation by the remote control unit (Refer to TEST RUNNING).

The operation indicator lamp and timer indicator lamp will begin to flash simultaneously during test run.

- (4) Close the valve stem of 3 way valve when the reading on the compound pressure gage becomes 0.05-0 Mpa (0.5-0 kg/cm²).
- (5) Stop the operation.
 - Press the START/STOP button of the remote control unit to stop the operation.



CAUTION

During the pump-down operation, make sure that the compressor is turned off before you remove the refrigerant piping.

Do not remove the connection pipe while the compressor is in operation with 2 way or 3 way valve open. This may cause abnormal pressure in the refrigeration cycle that leads to breakage and even injury.